

Product Features

- Small size by using simple matching circuit board
- Single Supply Voltage
- Heat sink 99.9% copper, gold plated
- High Productivity
- Low Manufacturing Cost
- GaAs HFET

Application

- RF Sub-Systems
- Base Station
- IMT-2000



Package : DP-36

Description

The power amplifier module is designed for base stations and cell extenders and operating frequency range is from 300MHz to 2.3GHz.

GaAs HFET is used and attached on a copper sub carrier. It is connected by using bias and in/out matching circuit method with gold wire bonding.

The bias and matching circuit are designed much simpler than other circuits for silicon IC's, LDMOS because GaAs HFET is operated by low supply voltage whereas others are operated by high supply voltage.

For better thermal conductivity, enhanced mode PCB was used in the 99.9% copper gold plate heat sink.

This simplicity results cost competitiveness and performance enhancement.

Specifications

PARAMETER	RFA1930-03	RFA1950-03	RFA1970-03
Frequency Range (MHz)	1920~1940	1940~1960	1960~1980
Small Signal Gain (dB)	25		
Gain Flatness (Max.)	± 0.5dB @ 50MHz BW		
Gain Variation Over Temp		± 0.7dB (Typ.)	± 1.5dB(Max.)
VSWR (Input)	2 : 1		
Output P1dB	34 dBm (Min.)	35 dBm (Typ.)	
W-CDMA (1 FA)	27dBm @ -45dBc ACLR		
W-CDMA (4 FA)	23dBm @ -45dBc ACLR		
OIP3 @ tone / 23 dBm	48 dBm (Min.)	49 dBm (Typ.)	
Noise Figure (Typ.)	3.0 dB		
Drain Voltage	9V		
Drain Current	1.0A		
Operating Temp Range	-20°C ~ +70°C		
Dimensions (W×L×H)	29.0 × 30.2 × 10.1 [mm]		

NOTE

- * W-CDMA : Resolution bandwidth of equipment is 30kHz. Input signal is 3GPP TS25.141 v.3.4.1 Test Model 1, Chip Rate:3.84 Mcps, 64DPCHs/Carrier, 1 carrier @ ±5MHz and ±10MHz offset in 30KHz resolution bandwidth
- * Operation Bandwidth : 50MHz
- * RFA Series : Internally Matched Module

Performance Charts ($V_d=9V$, $I_d=1.0A$, $T=25^\circ C$)

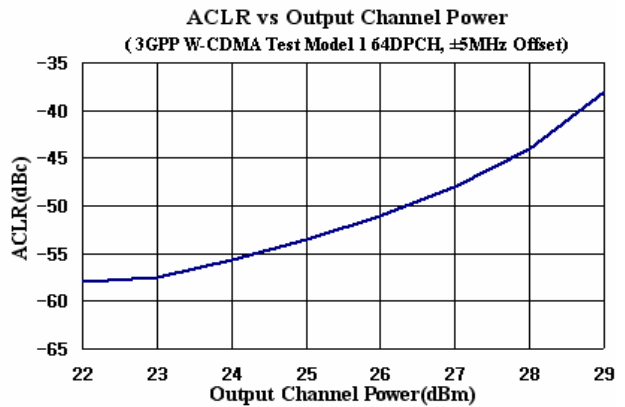
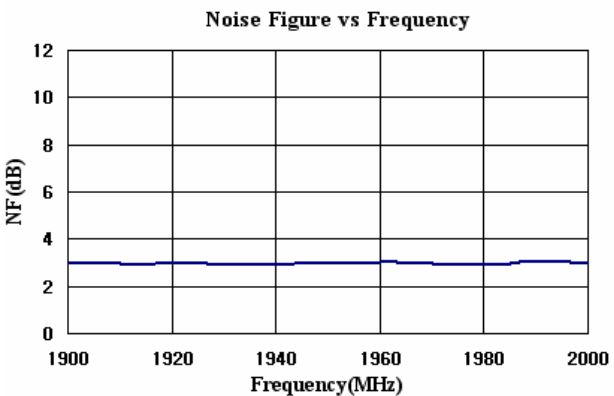
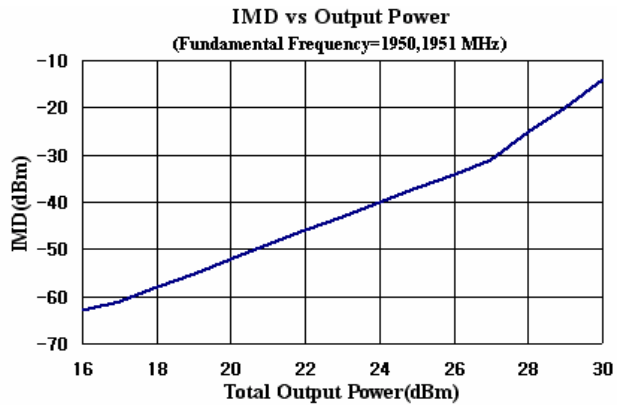
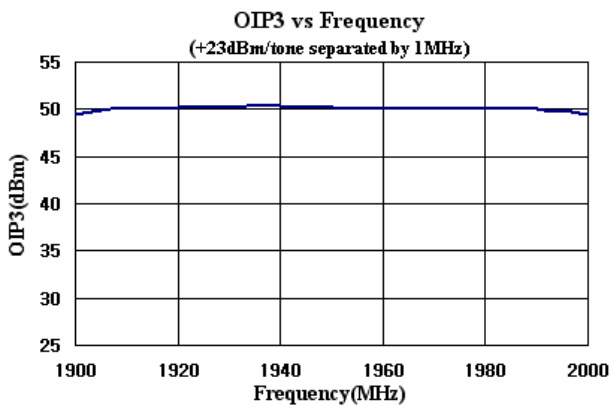
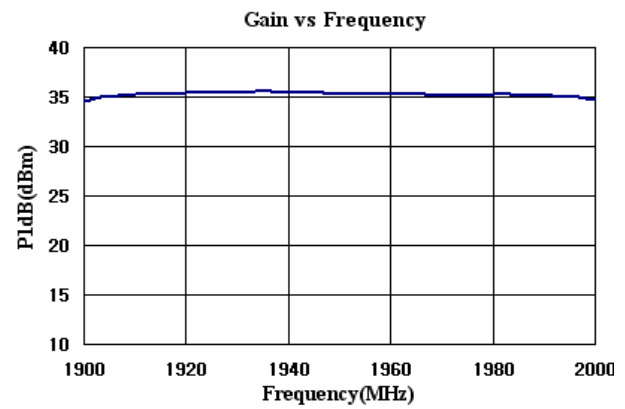
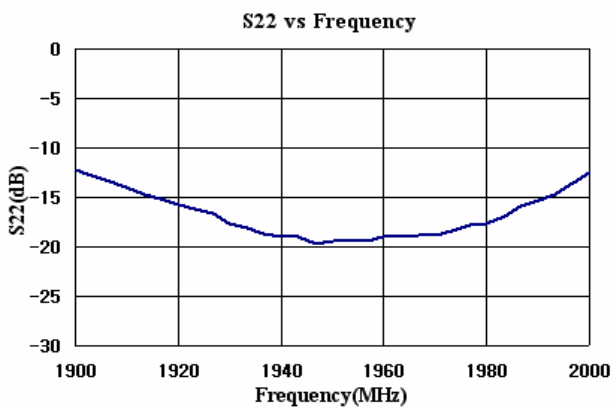
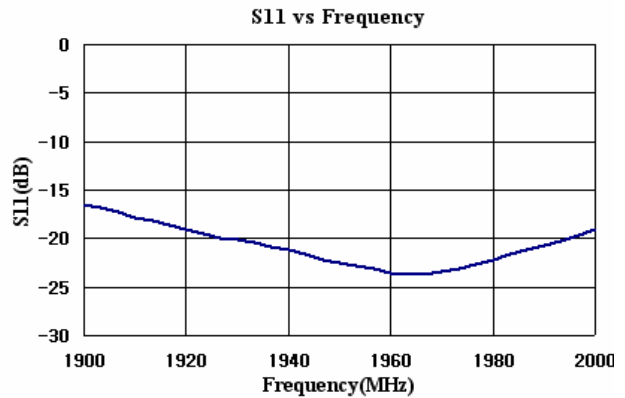
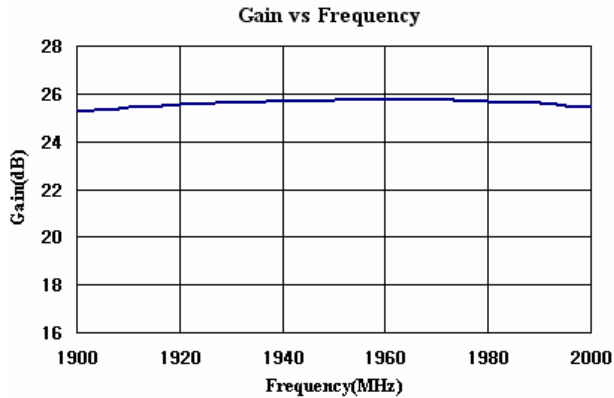

Package Dimensions (Type: DP-36)

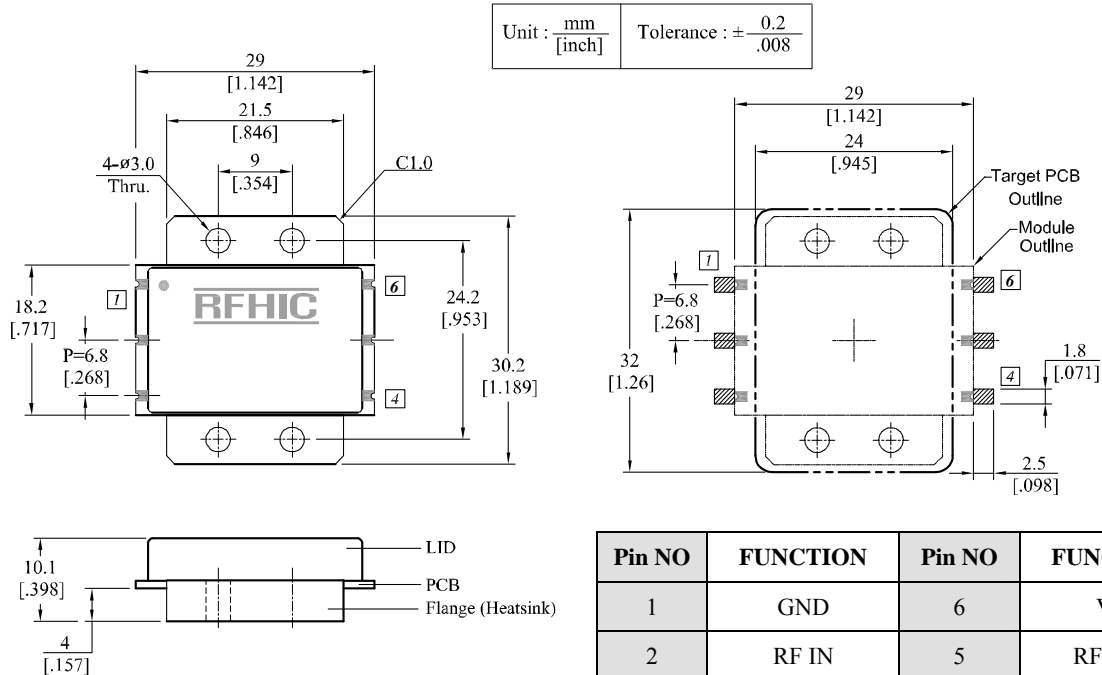

Installation Guideline

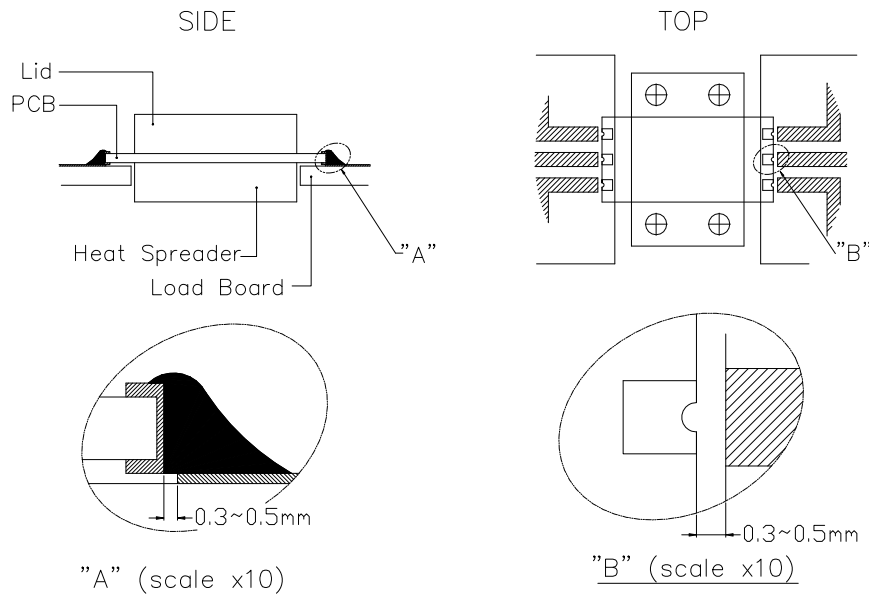

★ It can be easily removed with solder wick and other removable material.

RFHIC Corporation (RFHIC) reserves the right to make changes to any products herein or to discontinue any product at any time without notice. RFHIC do not assume any liability for the suitability of its products for any particular purpose, and disclaims any and all liability, including without limitation consequential or incidental damages. The product specifications herein expressed have been carefully checked and are assumed to be reliable. However, RFHIC disclaims liability for inaccuracies and strongly recommends buyers to verify that the information they are using is current before placing purchase orders. RFHIC products are not intended for use in life support equipment or application where malfunction of the product can be expected to result in personal injury or death. Buyer uses or sells such products for any such unintended or unauthorized application, buyer shall indemnify, protect and hold RFHIC and its directors, officers, stockholders, employees, representatives and distributors harmless against any and all claims arising out of such use. RFHIC's liability under or arising out of damages, claims of whatsoever kind and nature which RFHIC products could cause shall be limited in amount to the net purchase price of the products sold to buyer by RFHIC.